

TRANSFORMER SHEDS SITE

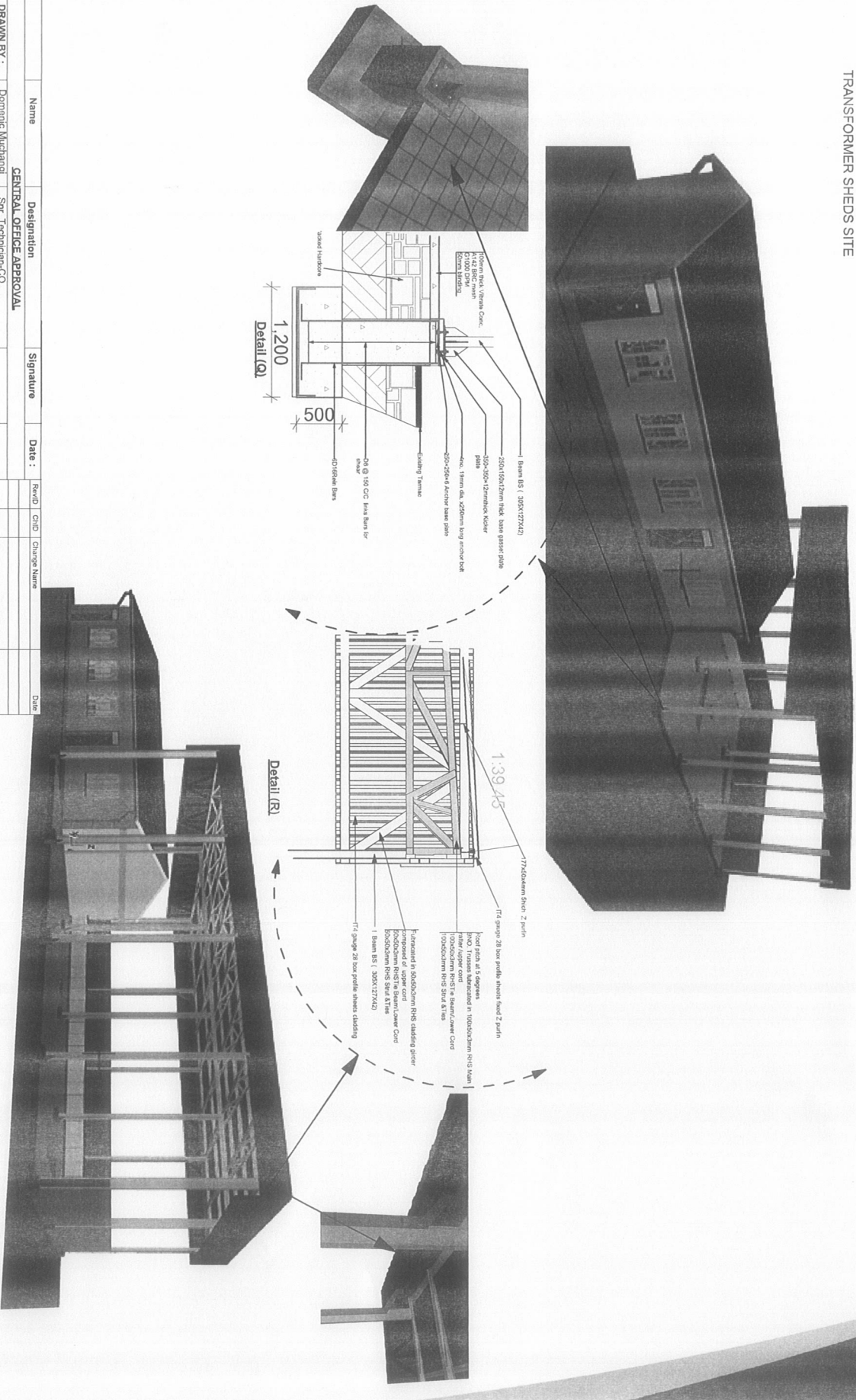

Name	Designation	Signature	Date :	Rec'd	QMB	Change Name	Date
CENTRAL OFFICE APPROVAL							
DRAWN BY :	Dominic Muchangi	Sr. Technician CO					
APPROVED BY :	Solomon Were	Principal Projects Officer					
APPROVED BY :	Mary Karira	Manager, Administration & Property					
REGIONAL APPROVAL							
APPROVED BY :	Duncan Machuka	CBM, Nyari County					
APPROVED BY :	Phinaas Marete	Regional Manager -Mt. Kenya					

JOB TITLE: PROPOSED CONSTRUCTION OF TRANSPORT REPAIR SHEDS AT KIGANJO 132 KV



SHEDS ELEVATIONS

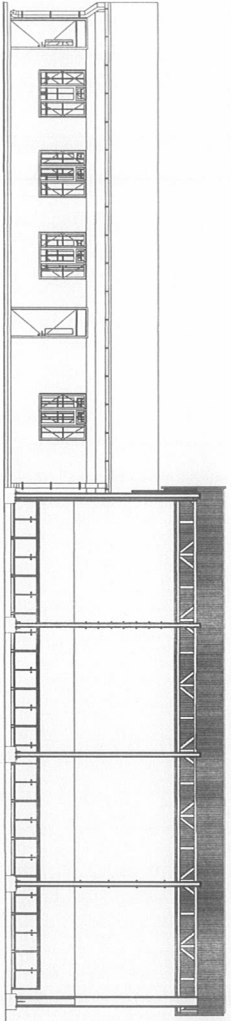

ELEVATION-FRONT

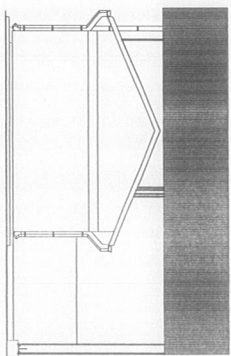

ELEVATION S-2

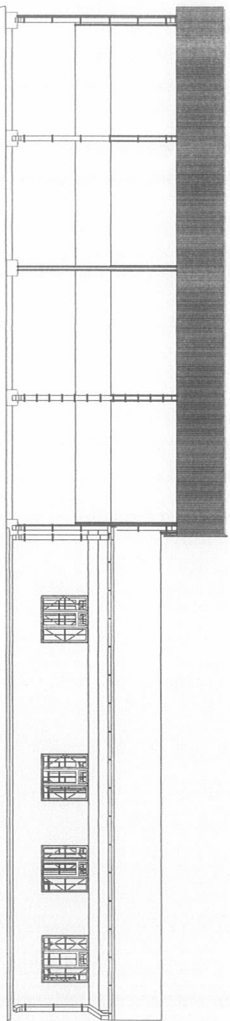

ELEVATION-REAR

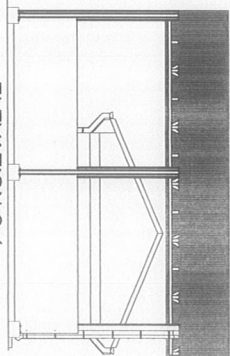

ELEVATION S-1

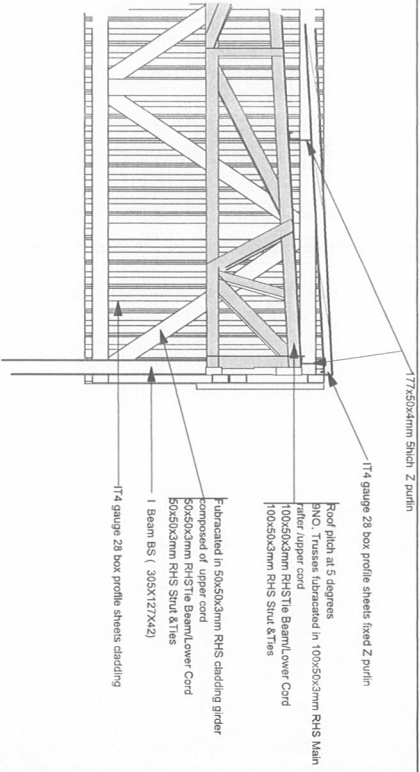

Detail (R)

Name	Designation	Signature	Date :	Rev#	CHD	Change Name	Date
CENTRAL OFFICE APPROVAL							
DRAWN BY :	Domenic Muchangi	Sr. Technician-CO					
APPROVED BY :	Solomon Were	Principal Projects Officer					
APPROVED BY :	Mary Kaaria	Manager, Administration & Property					
REGIONAL APPROVAL							
APPROVED BY :	Durcan Machuka	CBM, Nyeri County					
APPROVED BY :	Phinaas Marete	Regional Manager -Mt. Kenya					

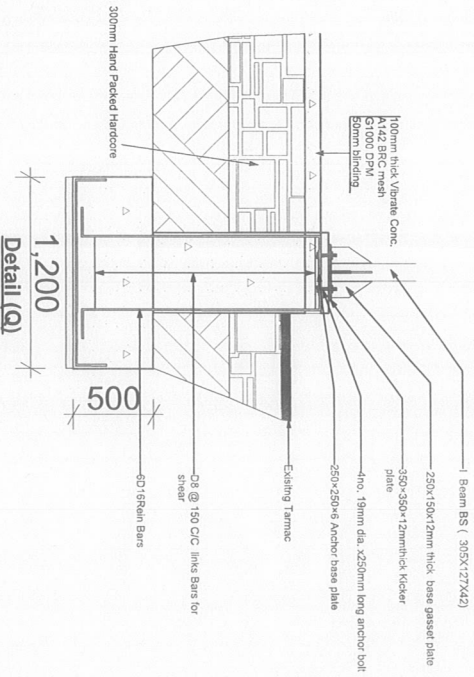

JOB TITLE: PROPOSED CONSTRUCTION OF TRANSPORT REPAIR SHEDS AT KIGANJO 132 KV



Sheet NO. 3

TRANSPORT FLOOR LAYOUT AND SECTION

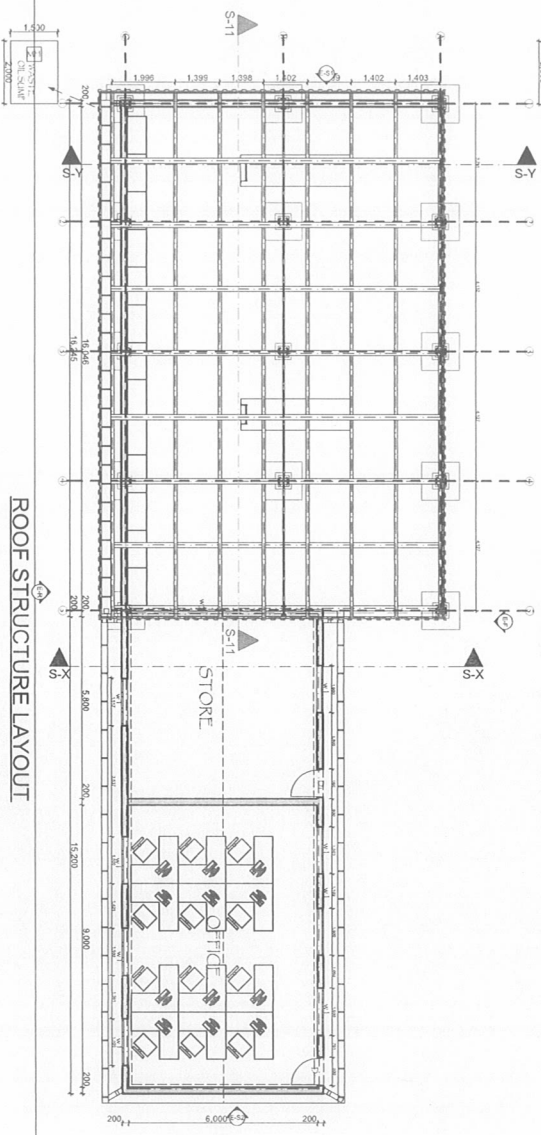
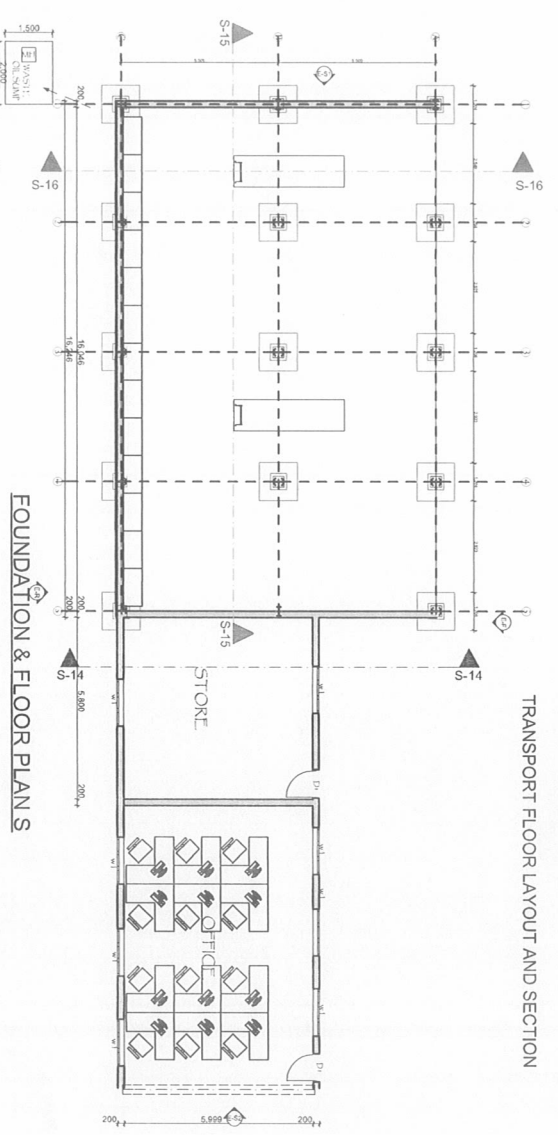

Name	Designation	Signature	Date	ROUND	CHD	CHANGI NAME	DATE
CENTRAL OFFICE APPROVAL							
DRAWN BY :	Dominic Muchangi	Sr. Technician-CO					
APPROVED BY :	Solomon Were	Principal Projects Officer					
APPROVED BY :	Mary Kaanta	Manager, Administration & Property					
REGIONAL APPROVAL							
APPROVED BY :	Duncan Machuka	CBM, Nyeri County					
APPROVED BY :	Pinases Marele	Regional Manager - Mt. Kenya					

JOB TITLE: PROPOSED CONSTRUCTION OF TRANSPORT REPAIR SHEDS AT KIGANUO 132 KV



Sheet NO. 1

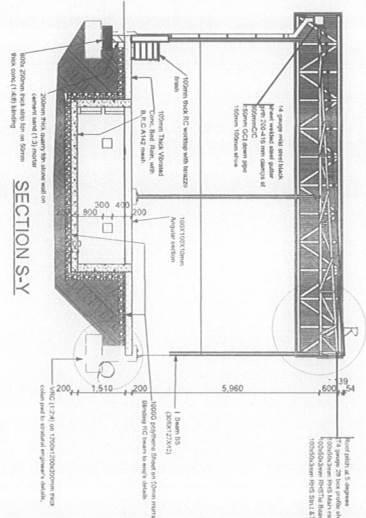
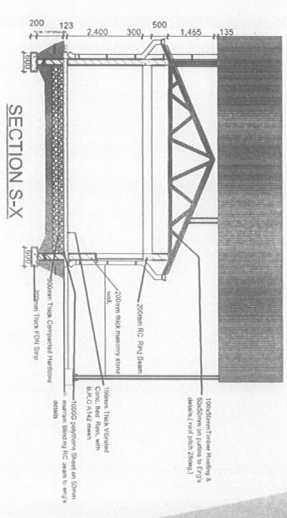

SECTION S-X

SECTION S-Y

ABLUTION BLOCK EXTENSION

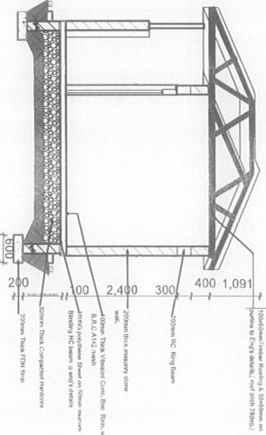
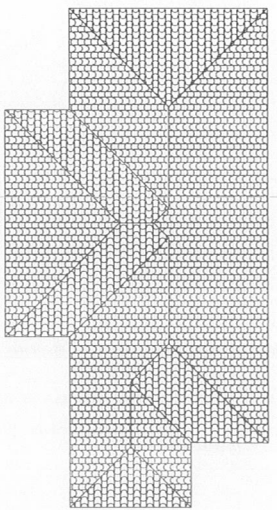
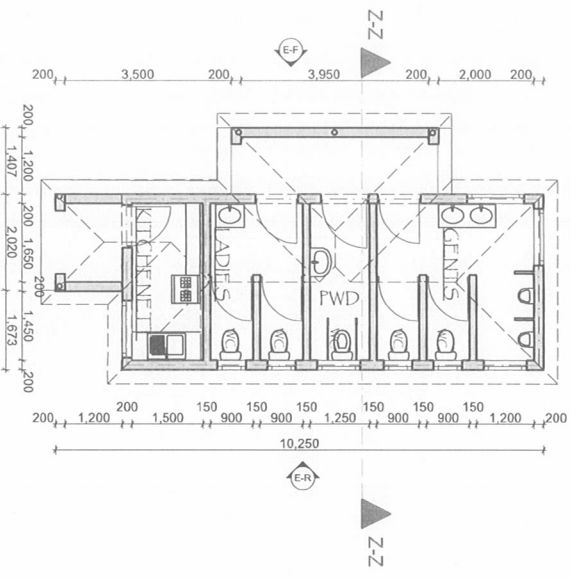
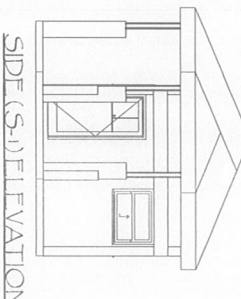
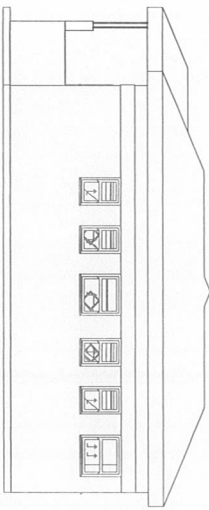
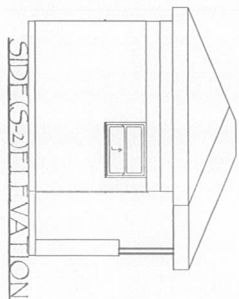
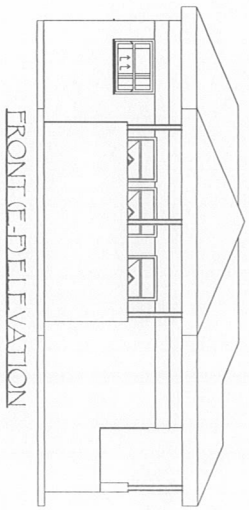
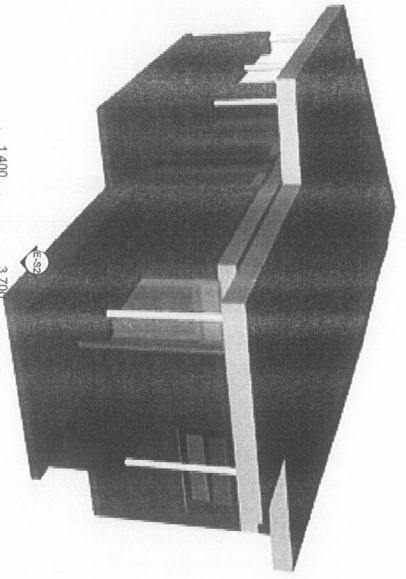

Name	Designation	Signature	Date	Rev#	CRP	Change Name	Date
CENTRAL OFFICE APPROVAL							
DRAWN BY : Dornene Muchangi	Snr. Technician-CO						
APPROVED BY : Salomon Were	Principal Projects Officer						
APPROVED BY : Mary Kaaria	Manager, Administration & Property						
REGIONAL APPROVAL							
APPROVED BY : Duncan Machuka	CBM, Nyeri County						
APPROVED BY : Phineas Marete	Regional Manager -Mt. Kenya						
JOB TITLE: PROPOSED ABLUTION BLOCK AT KIGANJO FOR STAFF WORKING AT TRANSPORT & TRANSFORM REPAIR SHED							
							Drawing Scale 1:100 Sheet NO. 1